

Title	AOX INC.		
Size	QUAD UART		
Doc	CUC-2 EVALUATION BOARD		
Rev	A 112		
Date	5-11-1999	B-43	Page 1 of 4

U101	MAX3222CAG	U102	MAX3222CAG
U103	MAX3222CAG	U104	MAX3222CAG

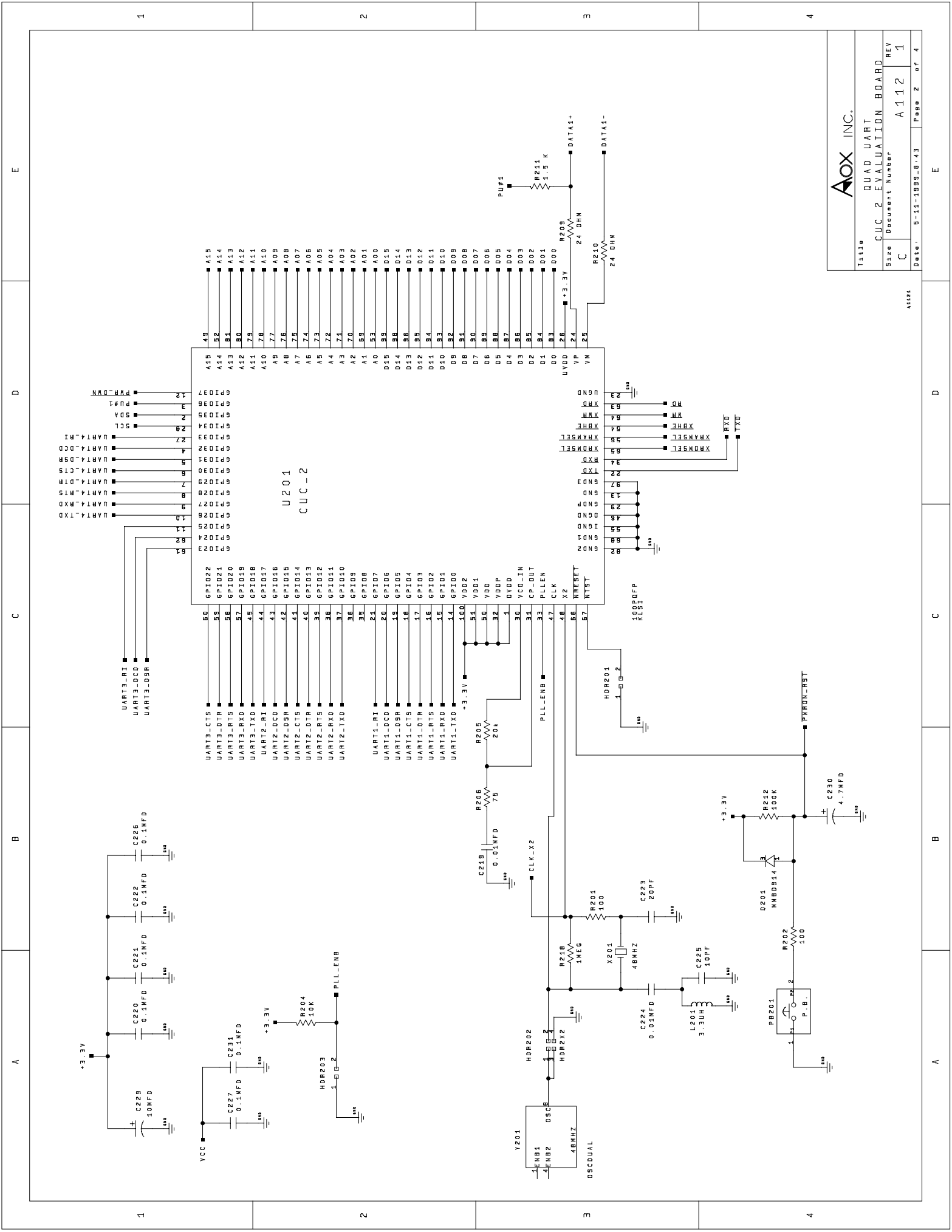

Title		Aox INC.	
Size		CUC 2 EVALUATION BOARD	
REV		A 112	
Date		5-11-1999-B-43	
Page		2 of 4	

A1121

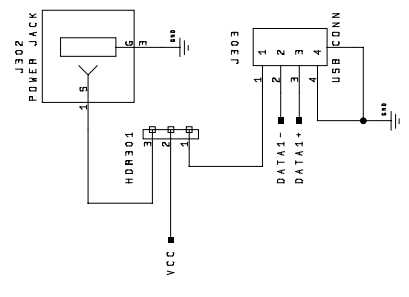
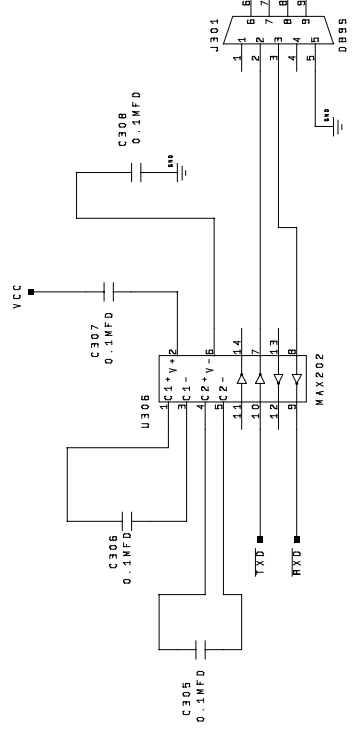
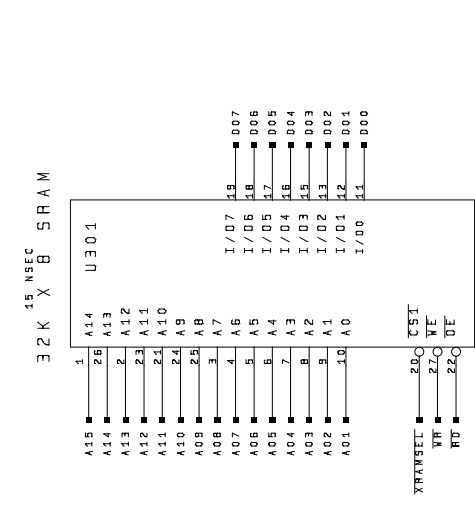
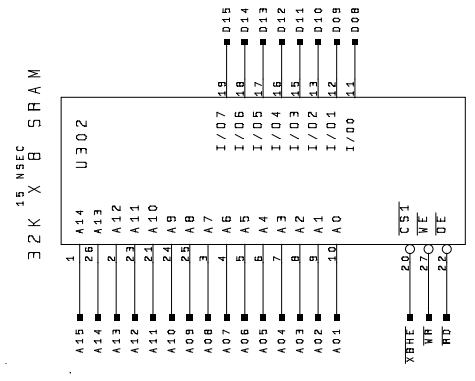
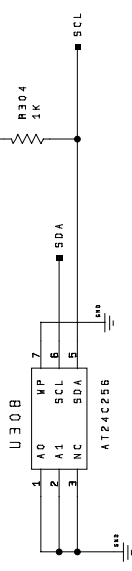
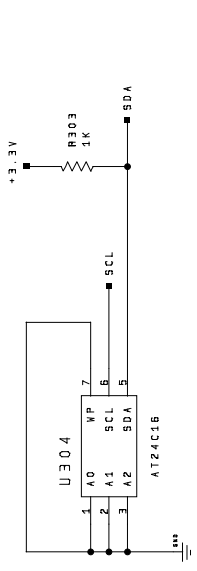
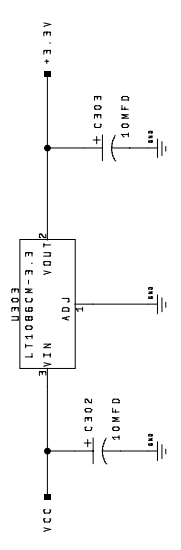

Title		Aox INC.	
Size		QUAD UART EVALUATION BOARD	
Document Number		CUC-2	
REV		A 112	
Date		5-11-1999-01.43	
Page		3 of 4	

